

BrunataNet

GateLAN Mbus/RS485

(type 2)

Installation guide

edition 2.0

UK-QB 101476/18.04.2013

Brunata a/s is a Danish owned company. We have more than 90 years of experience in delivering heat cost allocators, consumption accounts and meter services. Today meters are often remotely read with access to the internet. We have a quality control system fulfilling DS/EN ISO 9001 and 14001.

Brunata

The logo for Brunata features a horizontal bar below the company name. The bar is divided into two equal segments: the left segment is red and the right segment is dark blue.

Contents

1.0 Introduction	3
1.1 Connection generally	3
1.2 Tools	3
2.0 Connection of GateLAN – Mbus/RS485.....	4
3.0 Connection of meter types HGQ, HGS, HGV and HGP-SIV	5
4.0 Connection of cable in HGP volume meter	6
5.0 Connection of cable to Siemens Sonogyr-Mbus-master WZC-P120/250.....	7
5.1 Connection of cable to Relay M-Bus Level Converter 60.....	8
6.0 Registration of the installation	9
7.0 Light diodes and buttons on GateLAN – Mbus/RS485	10
8.0 SMS Text commands to the GateLAN Mbus/RS485.....	11
9.0 Check and register.....	12
9.1 Which elements does the check contain?.....	12
9.2 Does the GateLAN Mbus/RS485 controller have contact with the server?.....	12
9.3 Did the GateLAN Mbus/RS485 find all the meters?.....	12
10.0 Registration of components in the network.....	12
8.0 Technical support.....	12

Appendix: BrunataNet – component list

1.0 Introduction

1.1 Connection generally

GateLAN – Mbus/RS485 is connected to 230 V and an Ethernet with dynamic IP addressing DHCP, through which access to the internet can be achieved.

Up to 20 HG meters can be connected to GateLAN – Mbus/RS485, provided the total cable length does not exceed 1000 m.

GateLAN – Mbus/RS485 is supplied with 3 m cable. Additional cable can be ordered separately under product no. 04-2020-C.

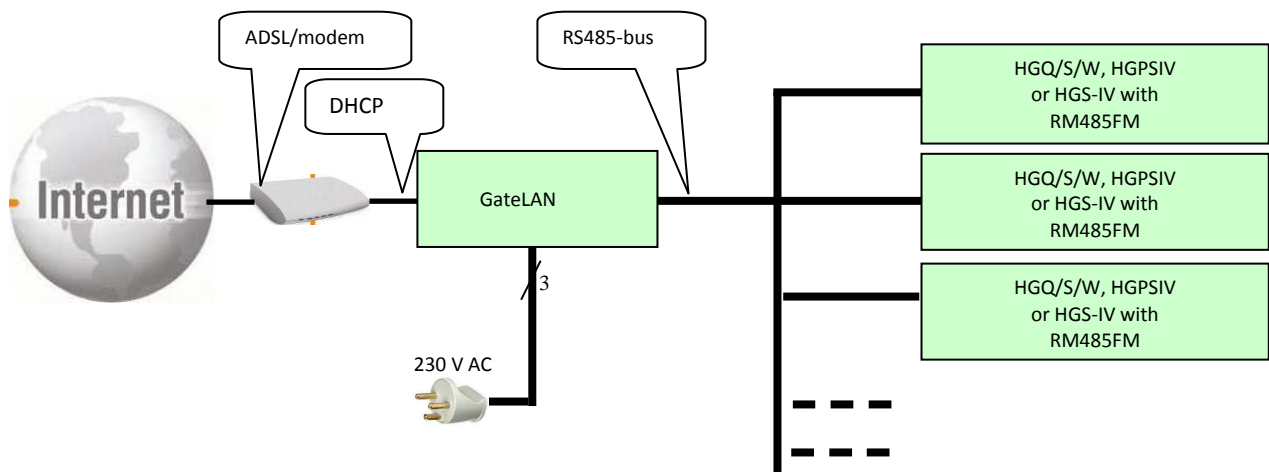

1.2 Tools

GateLAN – Mbus/RS485 is supplied with a simple plastic LSA installation tool.



If you need to install several GateLAN – Mbus/RS485, a better LSA installation tool called Krone LSA-PLUS is recommended (Brunata product no. 06-1040-C).

This is also used for installing the four-conductor cable to the RS485 bus in GateLAN.



2.0 Connection of GateLAN – Mbus/RS485

Connect local network or internet to the Ethernet socket.

Connect the HG meters to the RS485 bus using a four-conductor cable.

After connection of all meters and the internet, connect GateLAN – Mbus/RS485 to 230 V.

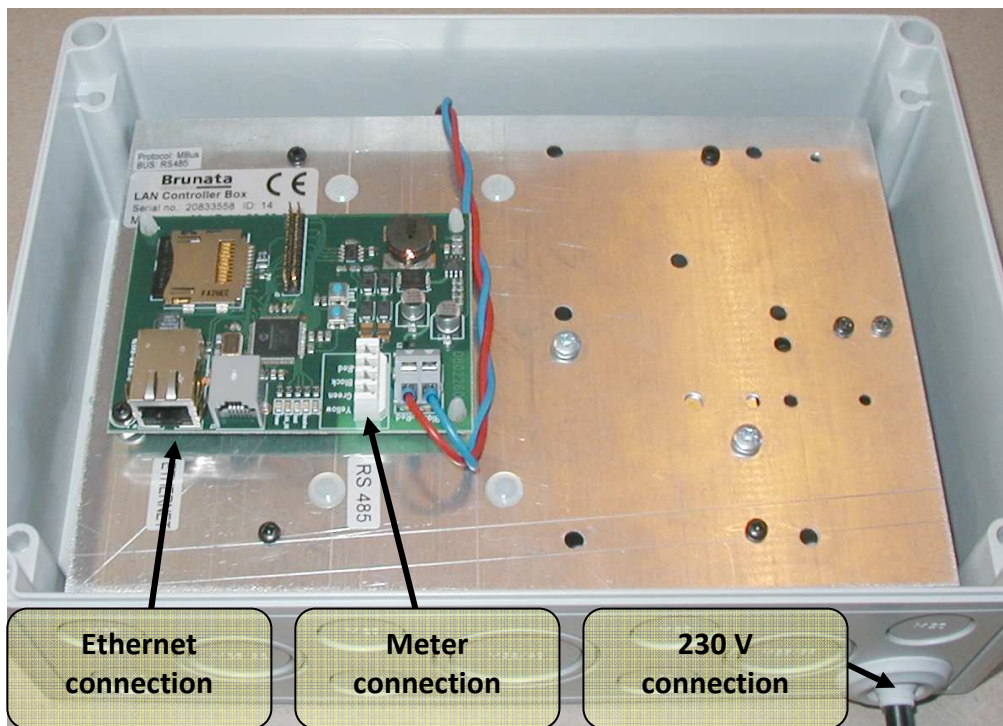

3.0 Connection of meter types HGQ, HGS, HGV and HGP-SIV

First install the four-conductor cable in the HG meter as shown in the illustration below.

If several HG meters are to be connected to GateLAN – Mbus/RS485, the cable must be looped on to the next HG meter.

Cable		Screw terminal
Green		B2
Black		A2
Yellow		B1
Red		A1

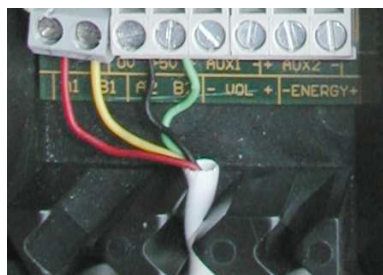



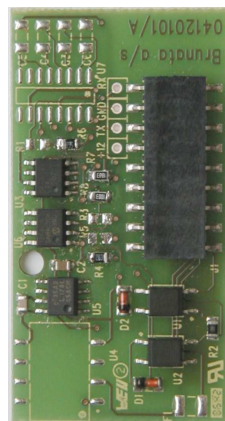
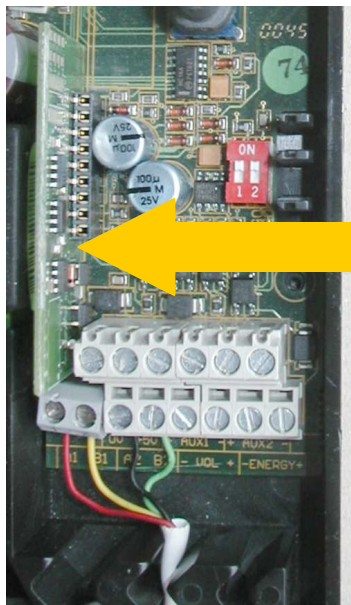

After installation of the four-conductor cable, insert the RS485 card (60-9027-B) in the HG meter as shown in the illustration below.



4.0 Connection of cable in HGP volume meter

First install the four-conductor cable in the HG meter as shown in the illustration below. If several HG meters are to be connected to GateLAN – Mbus/RS485, the cable must be looped on to the next HG meter.

Cable		Screw terminal
Green		B2
Black		A2
Yellow		B1
Red		A1

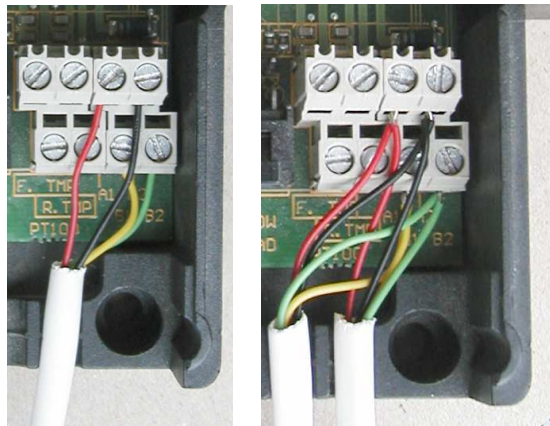

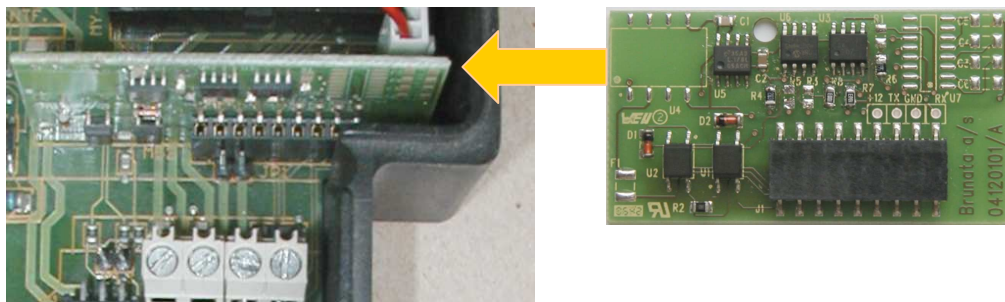

After installation of the four-conductor cable, insert the RS485 card (60-9027-B) in the HG meter as shown in the illustration below.



5.0 Connection of cable to Siemens Sonogyr-Mbus-master WZC-P120/250

In Siemens Mbus systems, GateLAN - Mbus/RS485 must be programmed for secondary address search. This can be done by the text command (net_type mbus_sec).

Cable		Screw terminal
Green		RxTx RTS
Black		GND
Yellow		RxTx TxD

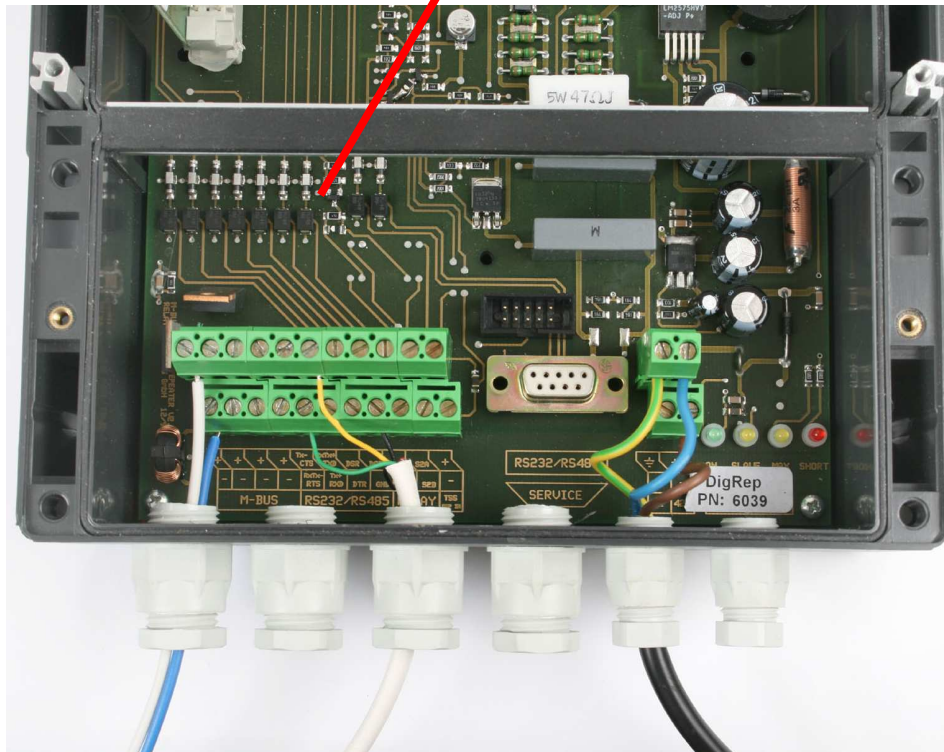
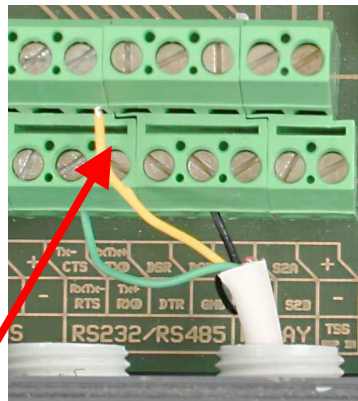

5.1 Connection of cable to Relay M-Bus Level Converter PW60

The GateLAN box shall in the Mbus system with Siemens meters be programmed to secondary address search. This can be done by SMS command (net_type mbus_sec)



Cable	Screw terminal
Green	RS485 S-
Black	GND
Yellow	RS485 S+



6.0 Registration of the installation

For the system to be set-up in WebMon, the form on the last page must be completed and sent to the relevant local Brunata branch or to the heating accounts department at the main office at Brunata, Herlev.

It is important to include both the serial number and the ID number of GateLAN – Mbus/RS485 on the form:

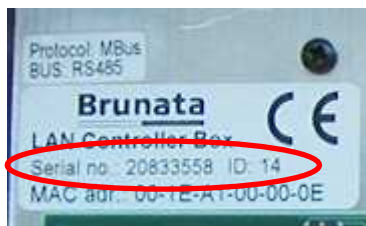

For the HG meter, only the meter number, on the side of the meter, need to be included:



The connection of the meters to GateLAN – Mbus/RS485 can be sketched on the back of the form.

7.0 Light diodes and buttons on GateLAN – Mbus/RS485

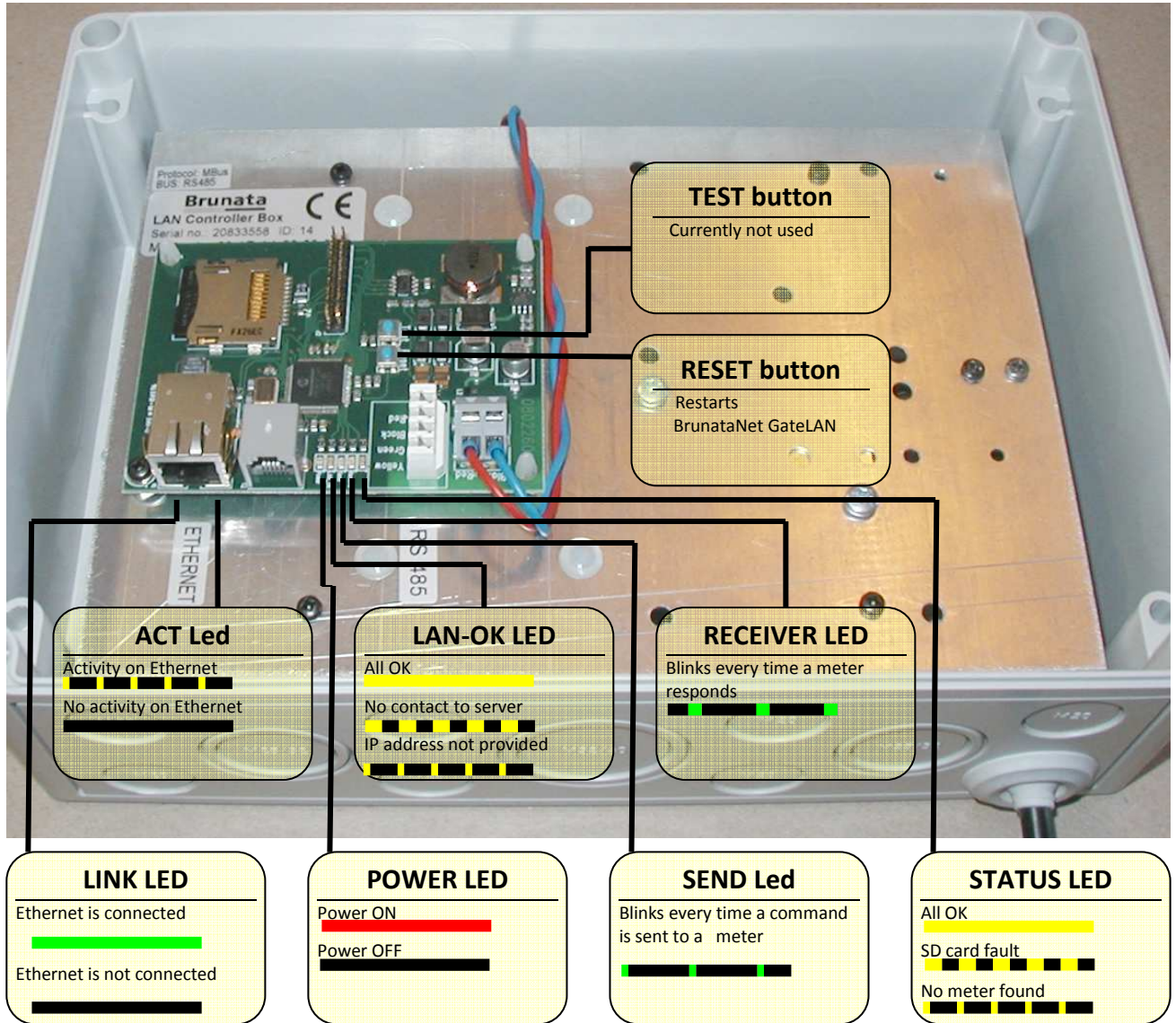

8.0 SMS Text commands to the GateLAN Mbus/RS485

If the GateLAN is correctly connected to the Internet and is connected to Brunata’s server (the LAN-OK LED is remains lit), it is possible to send SMS text commands to the box.

These SMS text commands are sent to telephone number: **+45 27 80 88 24**.

You need a password to use the SMS service. You can obtain a password from Product Management Instruments support on telephone number +4577 77 72 86 or by e-mail instruments@brunata.com

The text command must be constructed as follows: [password] [ID no. of the box] [command]

Standard commands:

Text command	Description
hardboot	Restarts the GateLAN Mbus/RS485 immediately
version	Inquires about the software version in the GateLAN Mbus/RS485
meters	Makes the GateLAN Mbus/RS485 search for meters and replies with the meter numbers within a few minutes
status	Writes out various status flags. These describe roughly the same facts as can be read on the LEDs if you have physical access to the GateLAN Mbus/RS485

An example of a text command is shown below where the sender wants to know the software version in GateLAN Mbus/RS485. The box has ID number 10, and the actual password:

Text command
password 10 version

Text reply
10 2.40

9.0 Check and register

9.1 Which elements does the check contain?

When the network is established, you must check that it works. The check consists of two parts:

- Does the GateLAN Mbus/RS485 have contact with the server at Brunata?
- Did the GateLAN Mbus/RS485 find all the meters?

9.2 Does the GateLAN Mbus/RS485 controller have contact with the server at Brunata?

First check if LAN-OK LED is lit constantly. Then send a text command to the GateLAN Mbus/RS485. If these two checks are successful, the GateLAN Mbus/RS485 can send data to the database at Brunata.

9.3 Did the GateLAN Mbus/RS485 find all the meters?

The following text command is sent to the GateLAN Mbus/RS485 to check if it has found all the meters included in the network. An example of a text command where the sender wants to know if all the meters has been found in GateLAN Mbus/RS485. The box has ID number 10, and the actual password:

Text command	Text reply
password 10 meters	10 39190744-HYD-2F-OC

10.0 Registration of components in the network

In order to monitor the network, it is **very important** to register all the components in the network.

- The ID number of the GateLAN Mbus/RS485
- The meter ID
- Where the meters is located in the building

A sketch of the composition of the network can be drawn on the back of the form, if required.

The form is passed to your local department, which will make sure that the component data are registered in WebMon.

11.0 Technical support

If you have any questions in connection with the above, please do not hesitate to contact Product Management Instruments support at:

Contact information:

Tel. +45 77 77 72 86

E-mail instruments@brunata.com

